

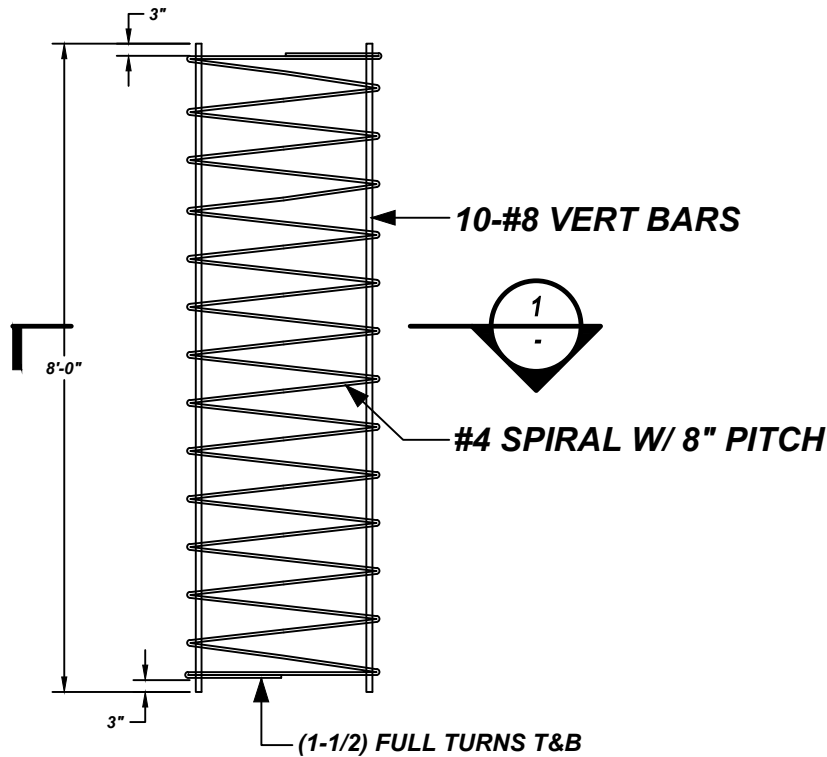

**1 SECTION**



**8'-0" X 24" WELDED CAGE**

REBAR GRADE 60 ASTM A-706					
REV No.	DATE	SENT FOR	REV No.	DATE	SENT FOR
HARMAC REBAR AND STEEL CORPORATION					
 A Division of A.H. Harris & Sons, Inc.					
P.O. Box 142 Cornshop Road Fryeburg, ME 04037			301 Hartle Street Sayreville, NJ 03301		
Tel. 800-294-4702 Fax 207-935-3058					
HARMAC STOCK CAGES					
Cage Details					
CUSTOMER:					
DESIGNER:					
DRAWN BY	DATE	JOB NO	SHEET NO.		
RMK	09.20.16	STOCK-1	R-WC1		